

# FORMING SHAPES

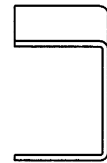

⑨

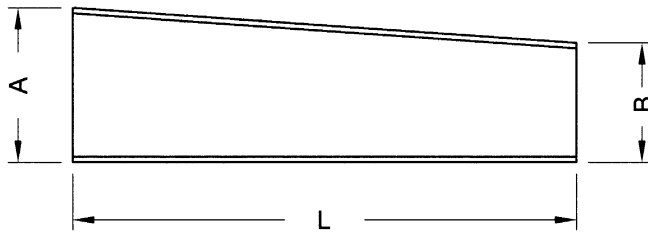
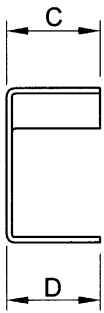
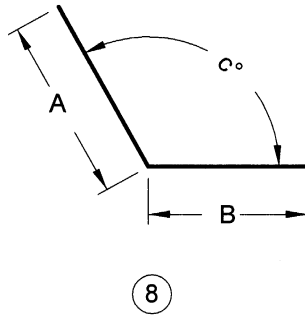
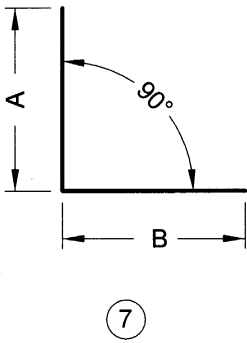
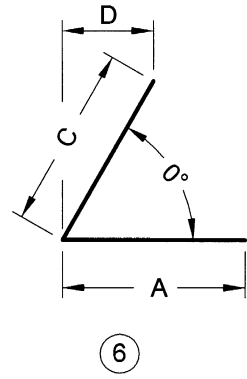
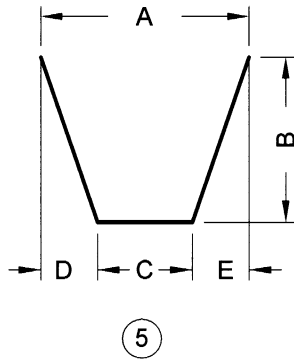
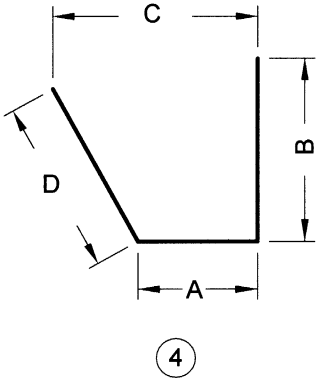
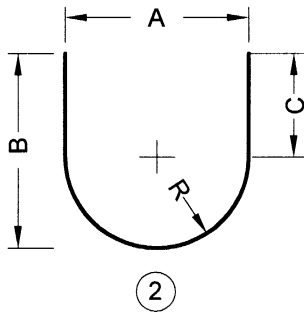
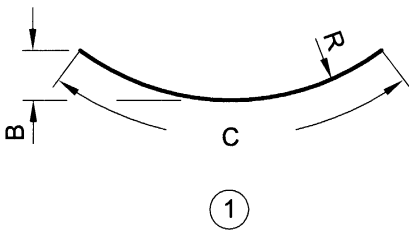
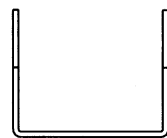
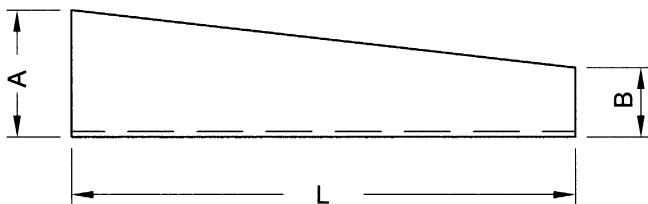
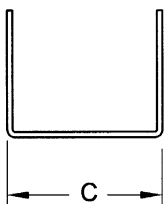

⑩

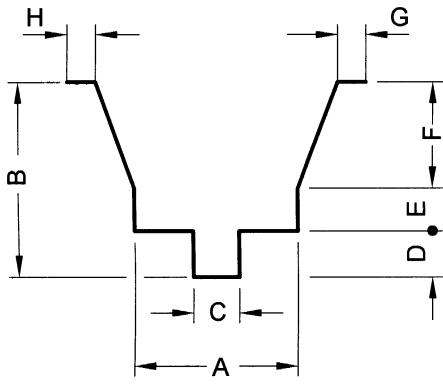

⑪

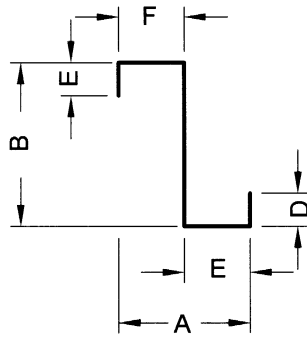

⑫

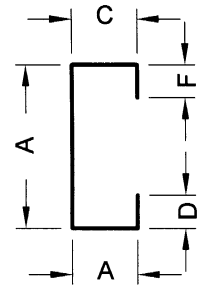

⑬

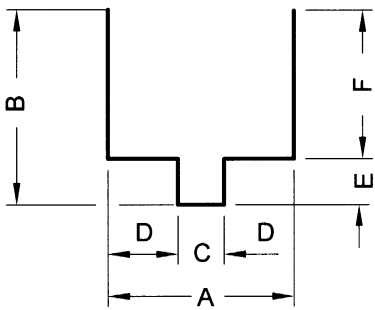

⑭

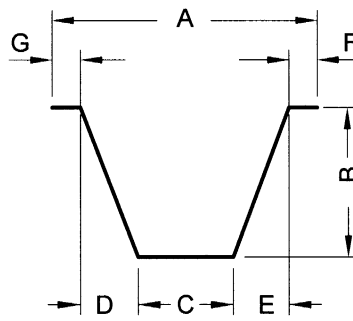

⑮

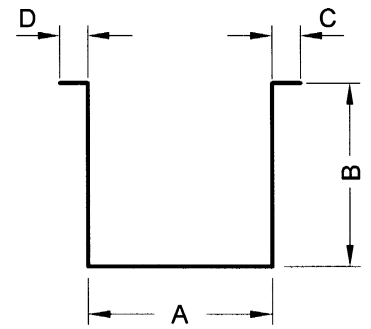

⑯

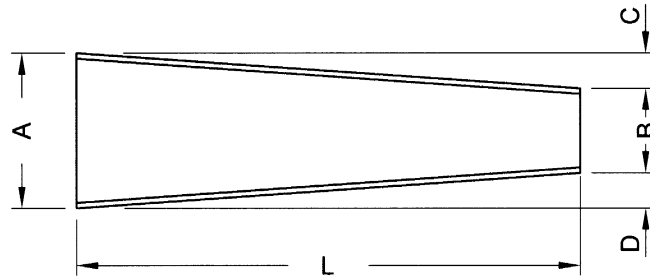
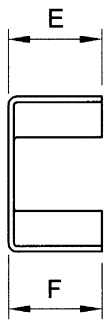

⑰

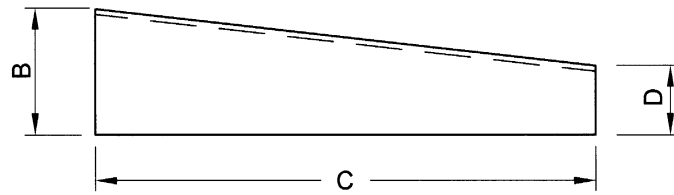
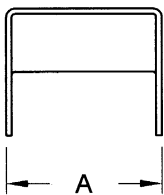
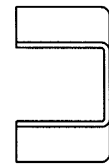

⑱

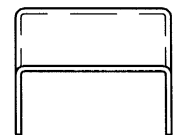

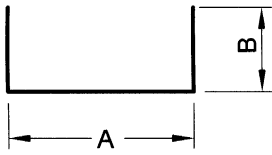

19

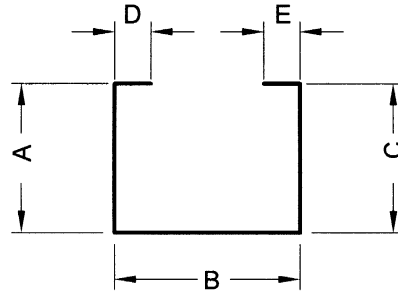

20

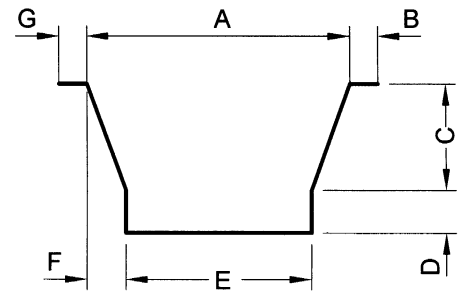

21

NOTE: NUMBERING IS INTENTIONALLY NOT IN SEQUENCE

STANDARD WOOD DECK  
TRUCK RAIL

57

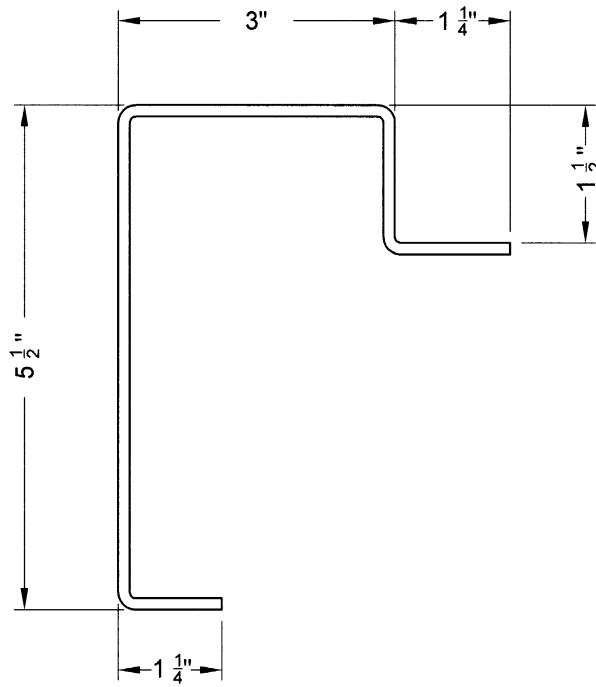

STANDARD TRUCK BEDS

58

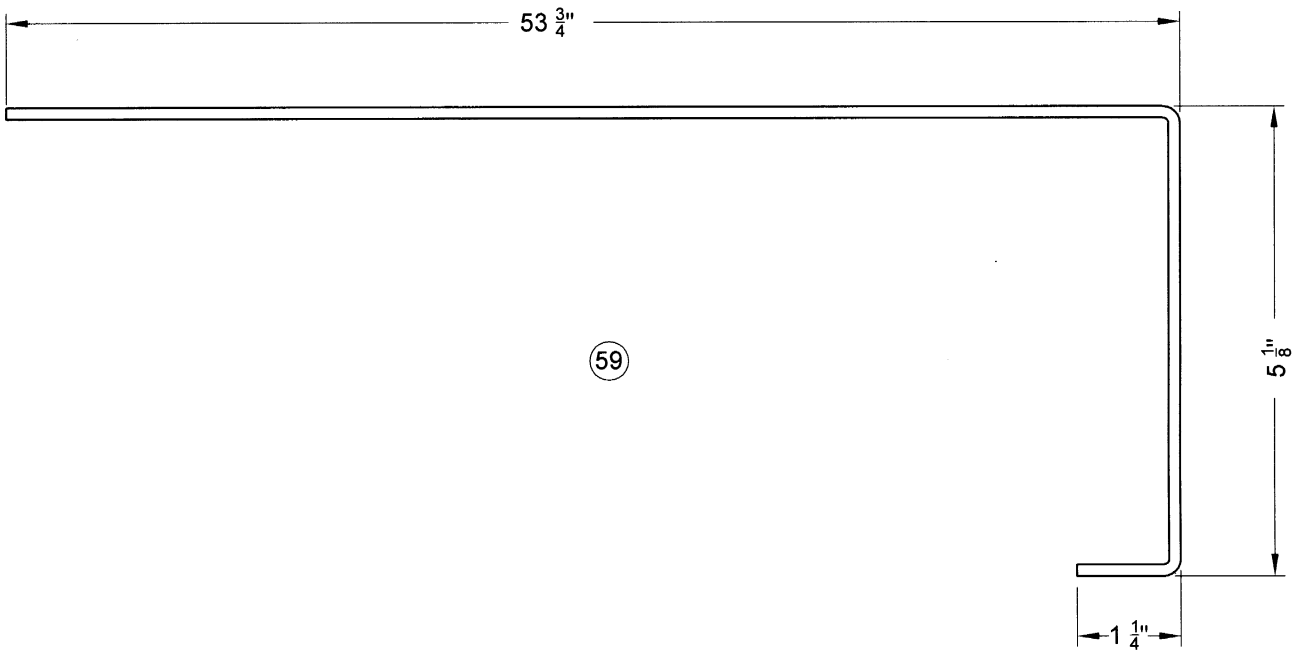
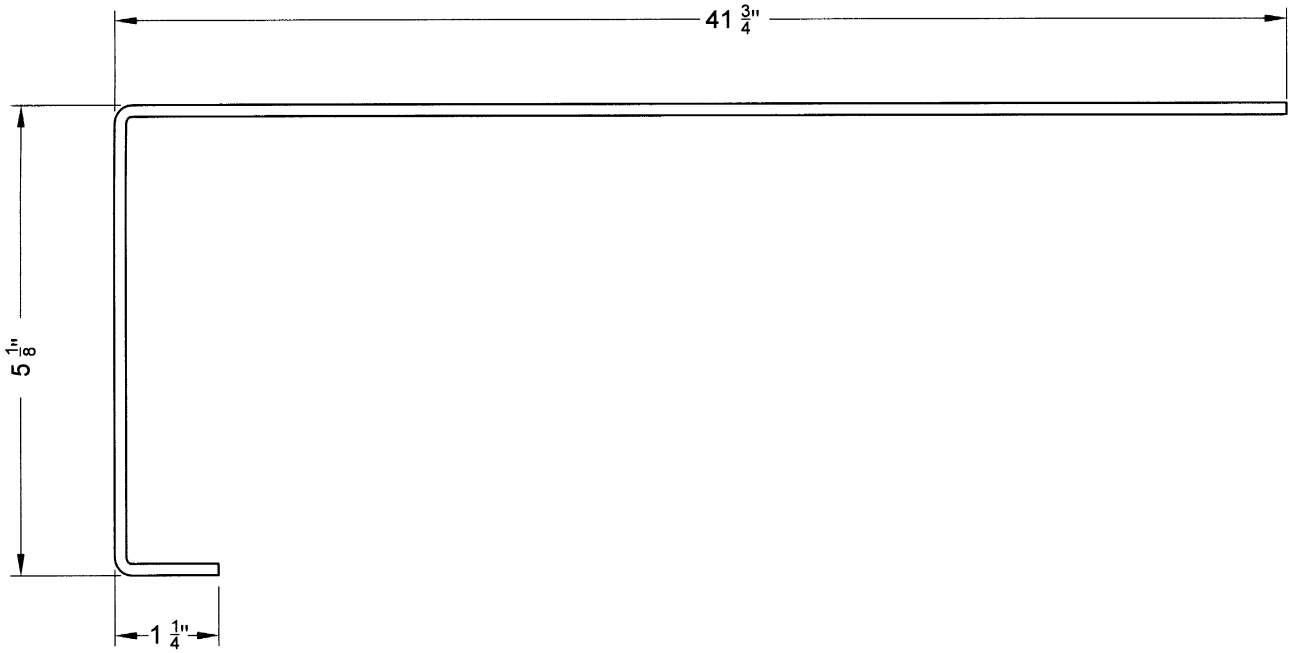

59

STANDARD TANKS

PART 'A' ID -

PART 'B' ID -

NOTE: BAFFLES CAN BE ADDED  
UPON REQUEST

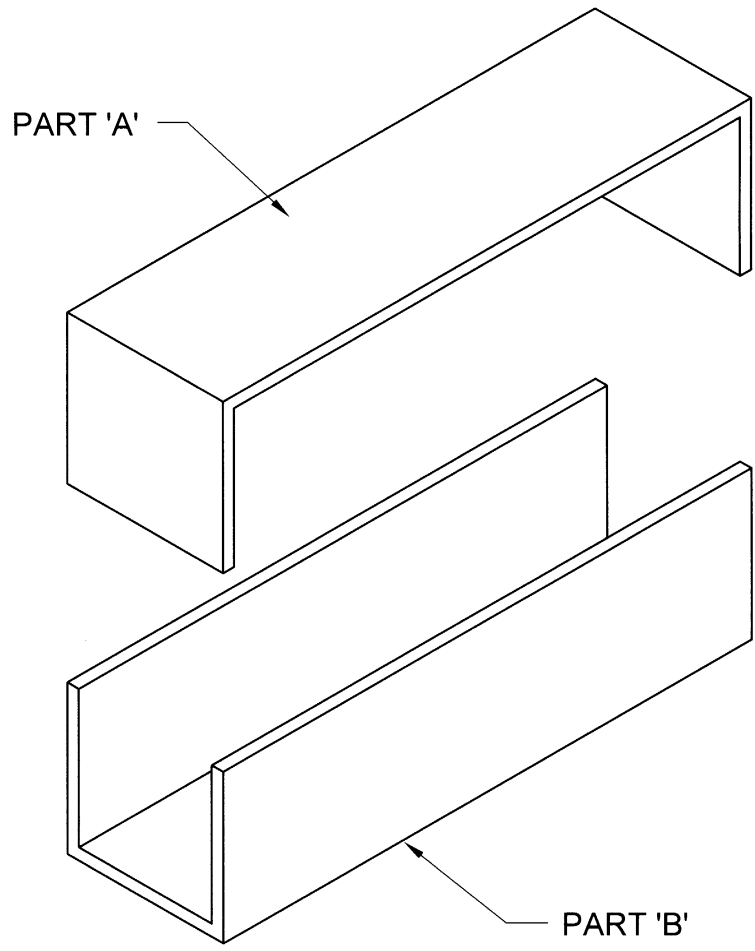

STANDARD CYLINDERS

61

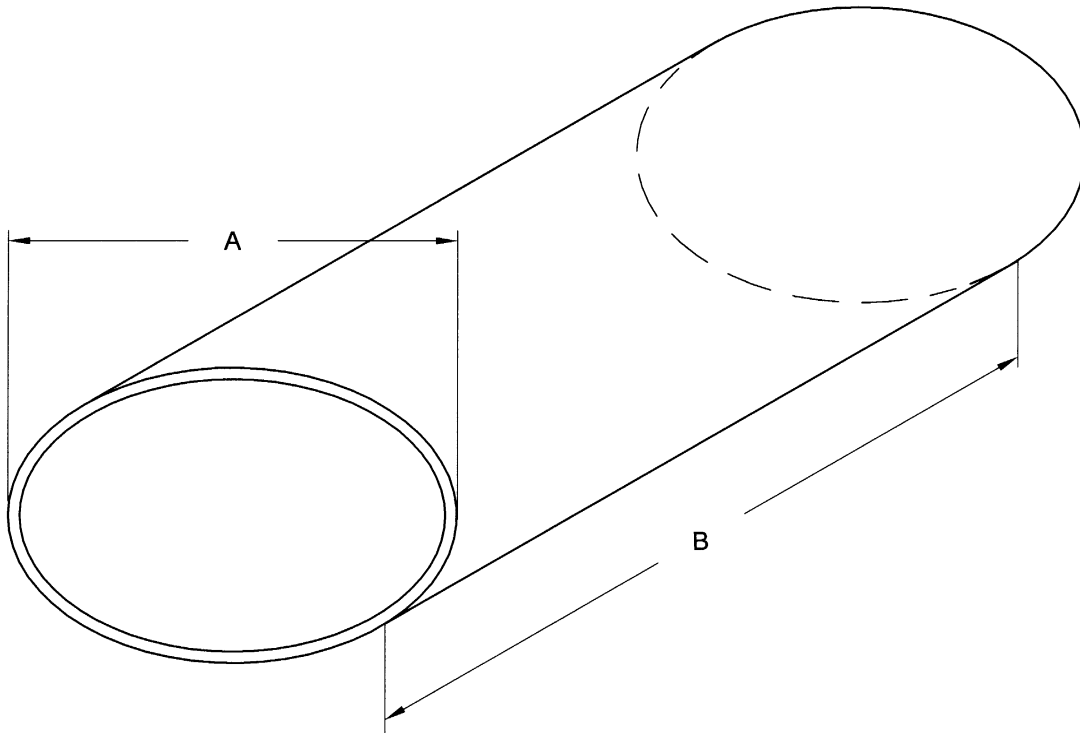

CONES / REDUCERS

62

